

**ENERGIZER EN95**

**D**

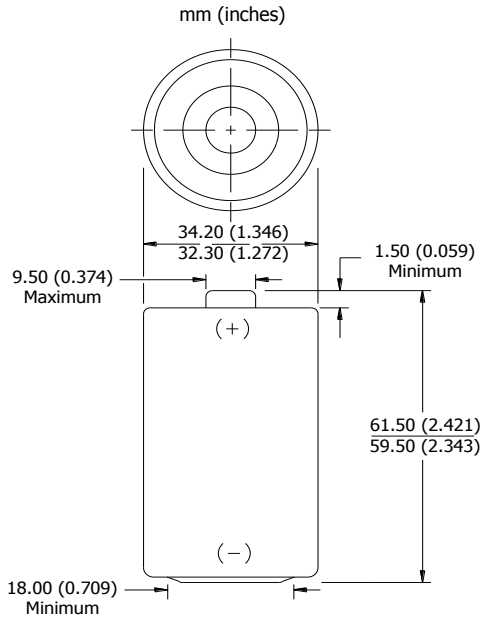

**Industry Standard Dimensions**



**Specifications**

**NOT INTENDED FOR RETAIL TRADE**

<b>Classification:</b>	Alkaline
<b>Chemical System:</b>	Zinc-Manganese Dioxide (Zn/MnO <sub>2</sub> ) No added mercury or cadmium
<b>Designation:</b>	ANSI-13A, IEC-LR20
<b>Nominal Voltage:</b>	1.5 volts
<b>Nominal IR:</b>	150 to 300 milliohms (fresh)
<b>Operating Temp:</b>	-18°C to 55°C (0°F to 130°F)
<b>Typical Weight:</b>	144.0 grams (5.1 oz.)
<b>Typical Volume:</b>	56.0 cubic centimeters (3.4 cubic inch)
<b>Jacket:</b>	Plastic Label
<b>Shelf Life:</b>	10 years at 21°C
<b>Terminal:</b>	Flat Contact

**Milliamp-Hours Capacity**

Continuous discharge to 0.8 volts at 21°C

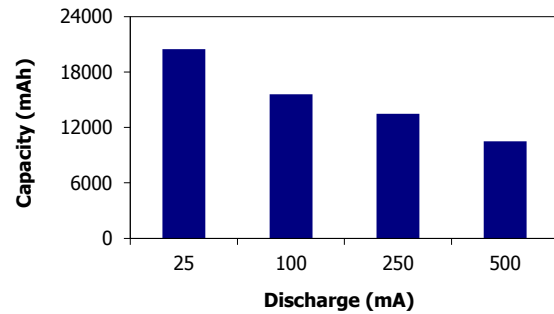

**Constant Resistance Performance**

Typical Characteristics (21°C)

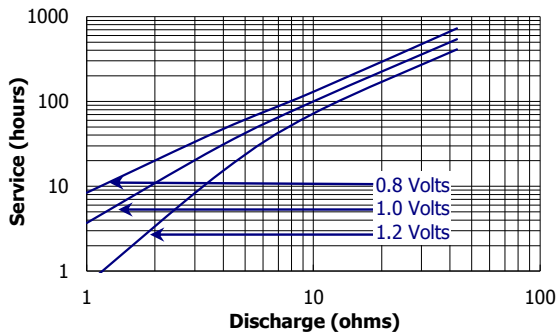

**Constant Current Performance**

Typical Characteristics (21°C)

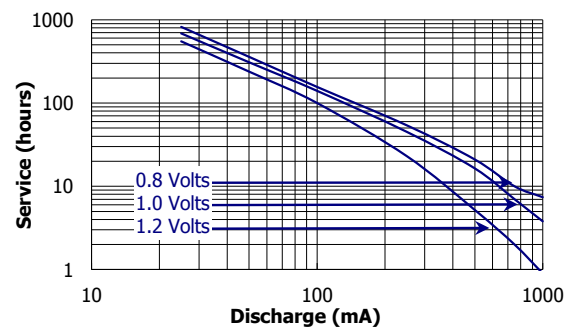

**Important Notice**

This data sheet contains typical information specific to products manufactured at the time of its publication.  
©Energizer Holdings, Inc. - Contents herein do not constitute a warranty.

ENERGIZER EN95



**Industry Standard Tests (21°C)**

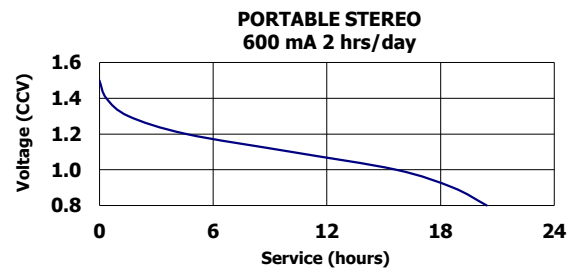
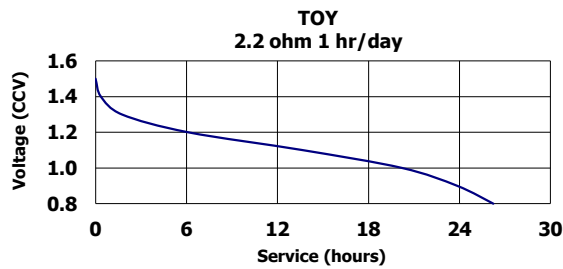
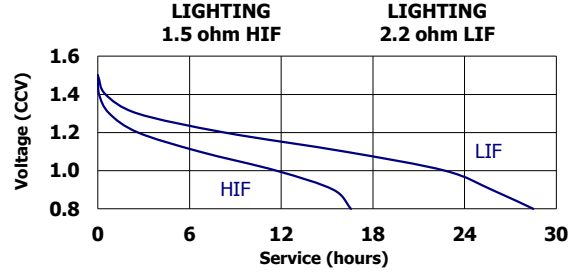
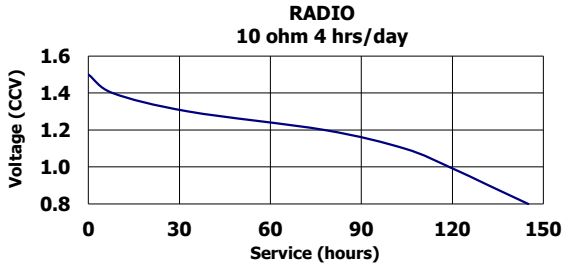

**Important Notice**

This data sheet contains typical information specific to products manufactured at the time of its publication.  
©Energizer Holdings, Inc. - Contents herein do not constitute a warranty.